

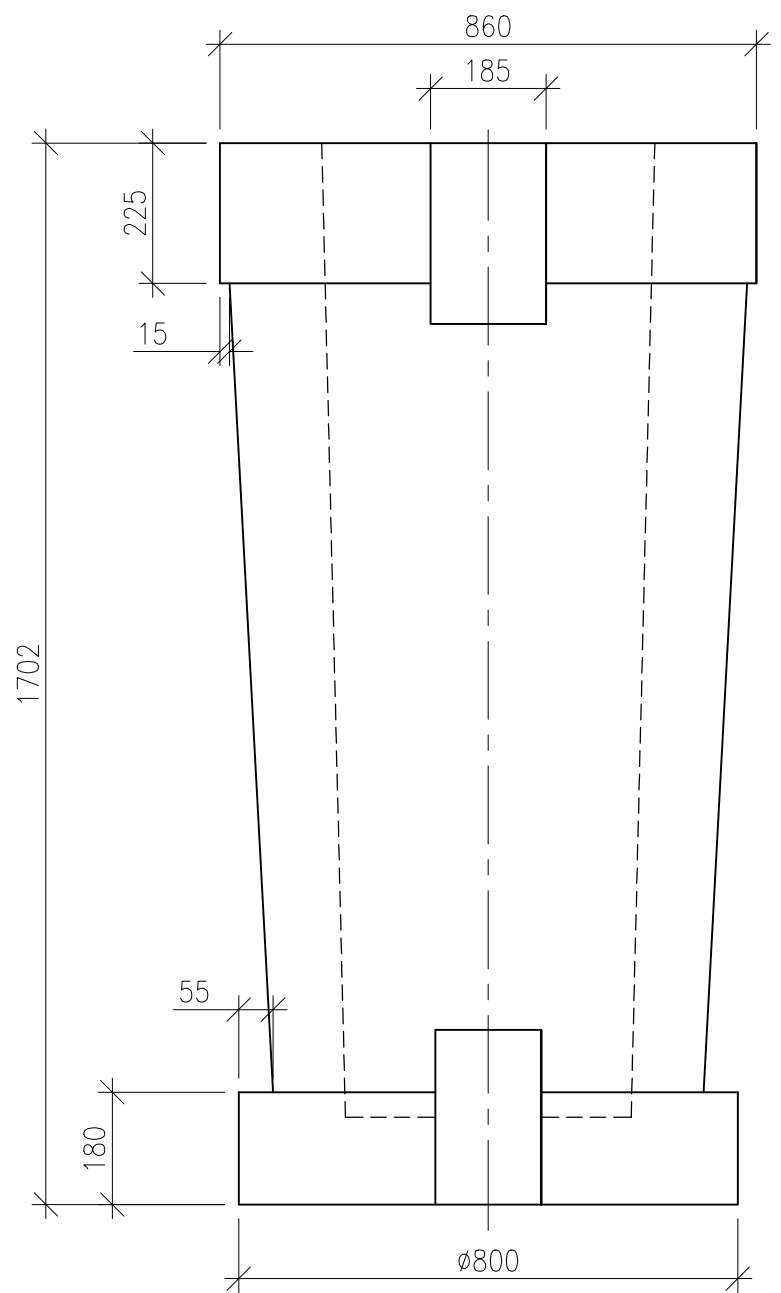

ELEVATION
SECTION - AA

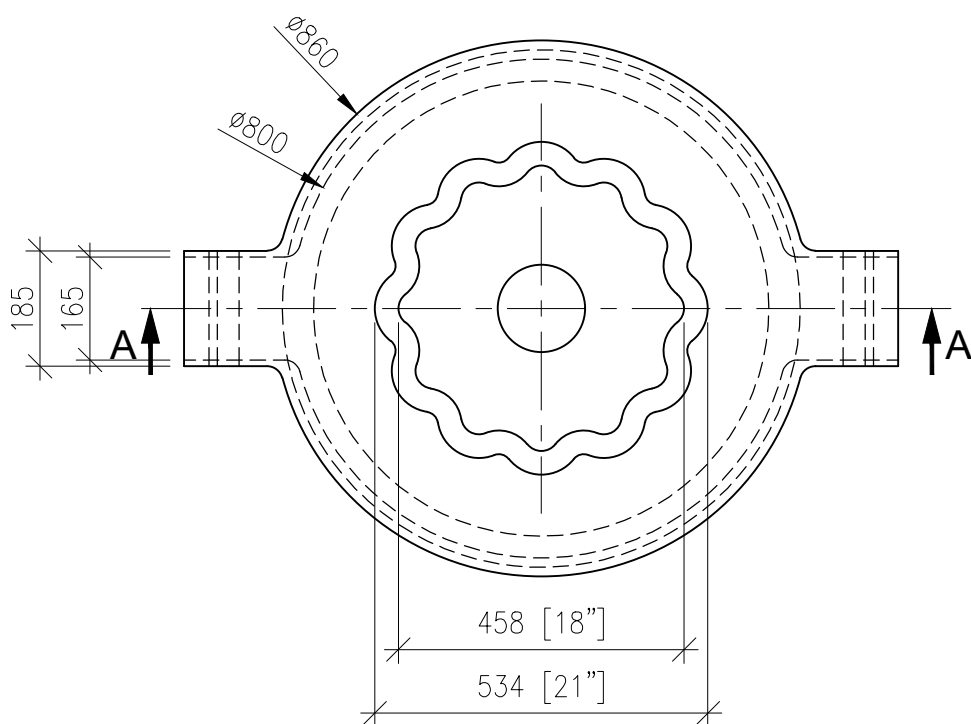

SIDE VIEW



TOP VIEW

TYPE :- FLUTED	MOULD SIZE		APPROVED BY : AKM	
DRG. NO LSL/MLD/010	INCHES 18 X 21 X 67	MM 455 X 530 X 1700	MOULD WEIGHT : 4165 KG	INGOT WEIGHT : 2300 KG
 LAXCON STEELS LIMITED		THIS DRAWING WAS ORIGINATED BY AND IS THE EXCLUSIVE PROPERTY OF LAXCON STEELS LTD. IT IS FURNISHED FOR RECIPIENTS INFORMATION ONLY AND IS NOT AN AUTHORISATION OR LICENSE TO MAKE CONSTRUCTION OR COPIES THEREOF TO FURNISH THIS INFORMATION TO OTHERS.		